



SPECIFICATION FOR APPROVAL

**Model : LFR-125/44 Shadowless Illumination –
Blue**

Model P/N : GL-LFR12544B-24

Customer :

Date : Nov. 02, 2015

Authorized Signature		
Approved By	Reviewed By	Prepared By
		

丞基技研股份有限公司 3AMechatronic Co., LTD.

Add.: 7F-7, No. 12, Lane 609, Sec. 5, Chongxin Rd., Sanchong Dist.,
New Taipei City 241, Taiwan (R.O.C)

TEL: +886-2-29997331

FAX: +886-2-22787113

1. Dimensions

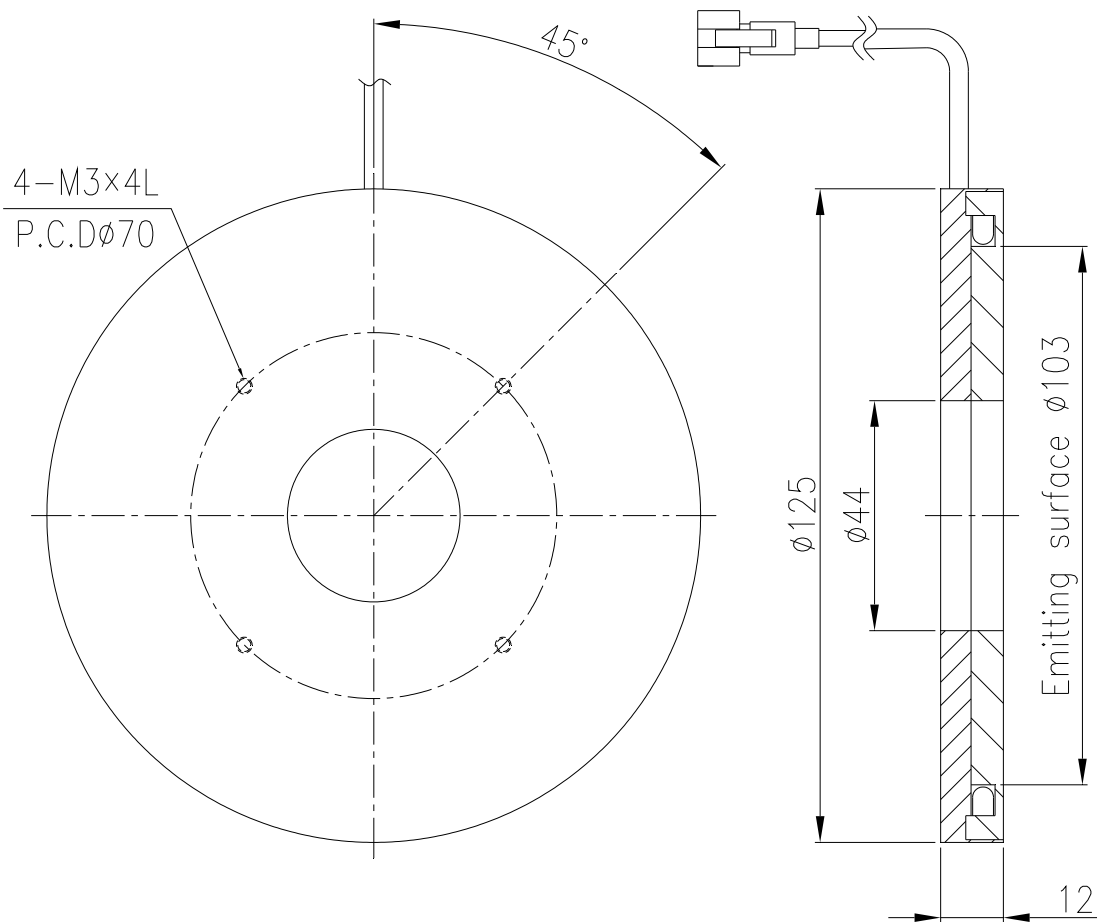

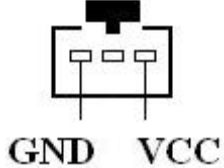
Material	Aluminum (Main Part)
Surface Treatment	Anodic Treatment (Black, Main Part)
Unit	mm
Tolerance	± 0.3
Connector Type	J.S.T connector SM type-3Pin
Connector Pin Def.	 <p style="text-align: center;">GND VCC</p>

Note: Owing to the different series of lights, the length of wires is about 25 – 30cm.

2. Guarantee

Under the normal use of the product, it will keep more than 80% of its initial brightness within a year from the date of delivery.

3. Specification

Input Voltage	DC 24V	Tolerance: $\pm 0.1V$
Max Power Consumption	5.28W	LED consumption only.
Operating Condition	Temperature	0 – 40°C
	Humidity	20 – 80%RH
	Cooling Method	Natural Air Cooling
Quantity of LEDs	88 pieces	

4. Specification of LED

Chip Source: NICHIA, CREE, OSRAM, SAMSUNG, or PHILIPS

Spectrogram:

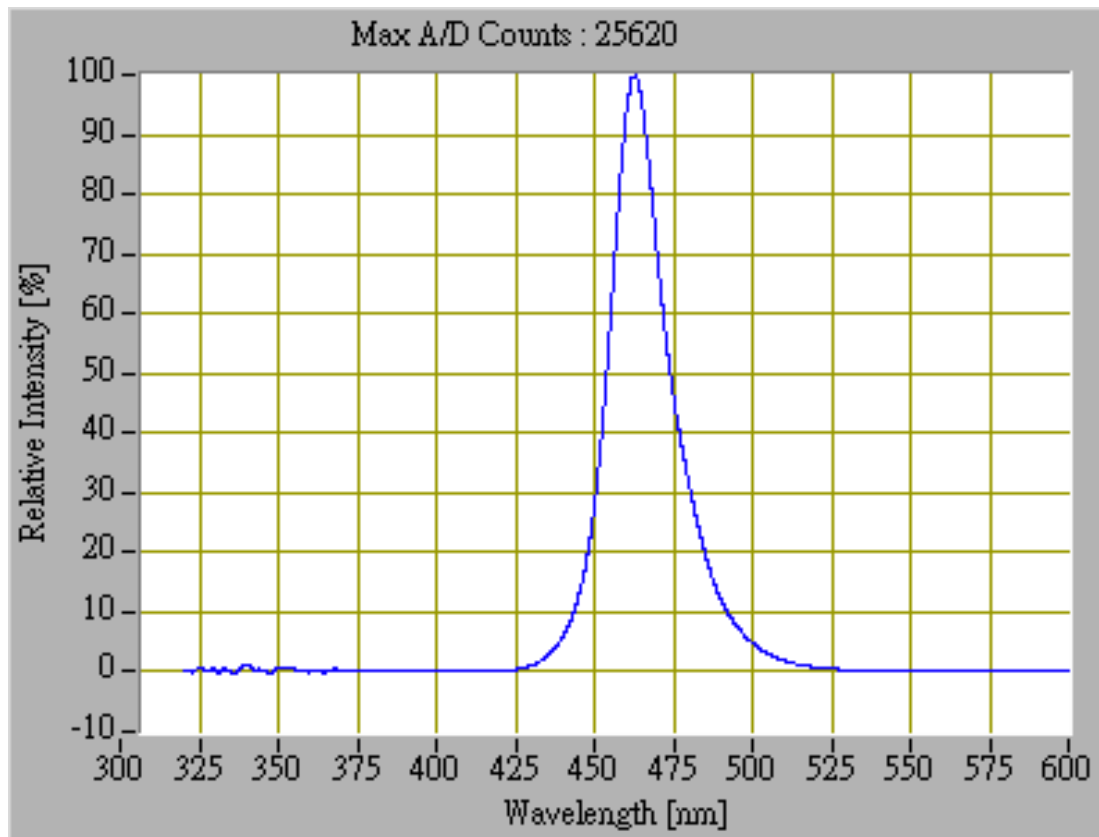

5. Illuminance Curve

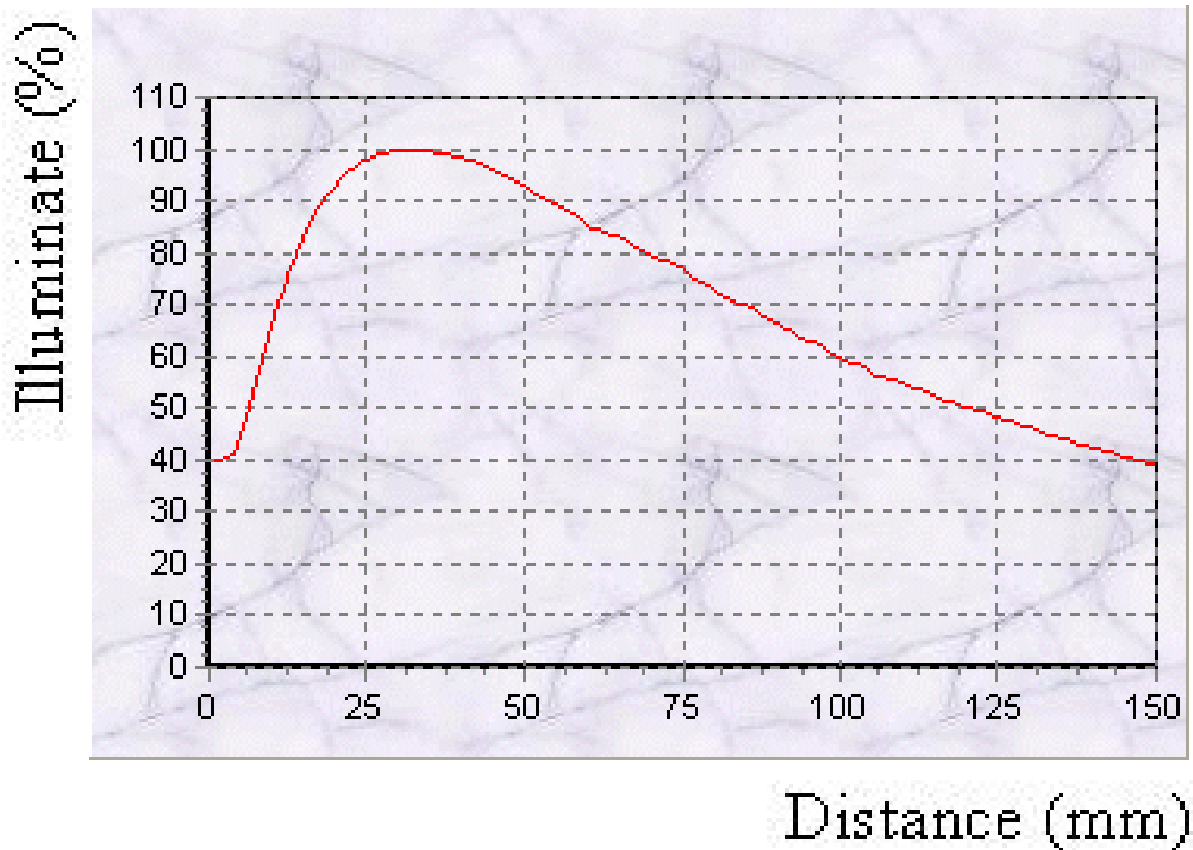

6. Brightness Distribution for LFR12544 Series

0cm

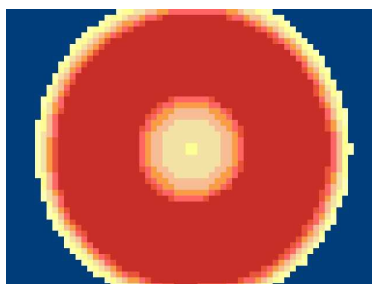

3cm

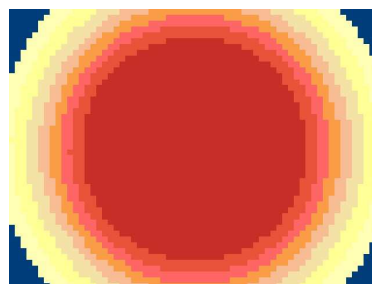

5cm

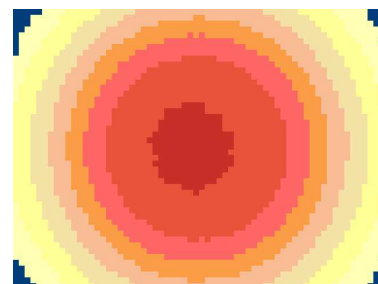

Brightness level



7.CE Certification

**SGS Taiwan Ltd.
Electronics & Communication
Laboratory**

134, Wu Kung Road,
WuKu Industrial Zone,
Taipei County, Taiwan 248
Tel: +886-2-2299-3279
Fax: +886-2-2298-2698



SGS

Verification No.: **EM/2007/70058C**

VERIFICATION OF EMC COMPLIANCE

Model No. : 3AM-DR-90/50W; 3AM-PR-136/108-W; 3AM-DO-54/11W;
3AM-DM-60/60W; 3AM-LDM-60/60W; 3AM-IFV-50W

Added Model(s) : Please see the ANNEX(—)

Product Name : LED LIGHT

Applicant : 3A MECHATRONIC CO., LTD.

Address of Applicant : 7FL.-7, NO.12, LANE 609, SEC.5, CHUNGSHIN RD., SANGHUNG CITY,
TAIPEI, TAIWAN 241, R.O.C.

Based on SGS EMC Test Report Number(s) : EM/2007/70058

Date of Receipt : 17 July 2007
Date of Test(s) : 17 July ~ 21 August 2007
Date of Issue : 21 August 2007
Test(s) Required :

Standards:

EN55015 : 2000+A1:2001+A2:2002	
EN61547 : 1995+A1:2000	
IEC61000-4-2 : 1995+A1:1998+A2:2000	IEC61000-4-3 : 2002+A1:2002
IEC61000-4-8 : 1993+A1:2000	

Conclusion

The apparatus meets the requirements of the above standards and hence fulfills the requirements of EMC Directive 2004/108/EC requirements.

*This certificate is only valid for the equipment and configuration described, and in conjunction with the test report as detailed above.

Authorized Signatory:



Victor Wen
SGS TAIWAN LTD.
Victor Wen

Copyright of this verification is owned by SGS Taiwan Electronics & Communication Laboratory and may not be reproduced other than in full and with the prior approval of the Manager of SGS Taiwan Electronics & Communication Laboratory.

Member of SGS Group (Societe Generale de Surveillance)

Any unauthorized alteration, forgery or falsification of the content or appearance of this report is unlawful and offenders may be prosecuted to the fullest extent of the law

This document is issued, on the Client's behalf, by the Company under its General Conditions of Service printed overleaf. The Client's attention is drawn to the limitation of liability, indemnification and jurisdiction issues defined therein.

Any other holder of this document is advised that information contained hereon reflects the Company's findings at the time of its intervention only and within the limits of Client's instructions, if any. The Company's sole responsibility is to its Client and this document does not exonerate parties to a transaction from exercising all their rights and obligations under the transaction documents.

SGSPAPER

04249853



All of our LED lights have obtained CE certification.

8. RoHS Certification



8, Lane 29, Wen-Ming Rd., Lo-Shan Tsun
Kui-Shan, Taoyuan County, Taiwan 33383
<http://www.etc.org.tw>
03-328-0026

Certificate

of Conformity for Directive 2002/95/EC (RoHS)

This is to certify enclosure(s) are in compliance with Directive 2002/95/EC on the Restriction of The Use of Certain Hazardous Substance (RoHS) in Electrical and Electronic Equipment.

Applicant: 3A Mechatronic Co., Ltd.

7F-7, No. 12, Lane 609, Chung-Hsin Rd., Sec.
5, San-Chung City, Taipei Hsien, Taiwan

Product/Sample: Shadowless Type LED

**Style/Type: PR-67/39R 、 PR-67/39W 、 PR-67/39B 、 PR-67/39G 、
PR-67/39Y 、 PR-67/39UV 、 PR-67/39IR 、 PR-90/58R 、
PR-90/58W 、 PR-90/58B 、 PR-90/58G 、 PR-90/58Y 、
PR-90/58UV 、 PR-90/58IR 、 PR-136/108R 、 PR-136/108W 、
PR-136/108B 、 PR-136/108G 、 PR-136/108Y 、
PR-136/108UV 、 PR-136/108IR**

Certificate No: 08-09-QAC-186

Date of Issue: October 17, 2008

This certificate of conformity is based on evaluated sample(s) of the product mentioned above. It does not imply the assessment of production of the product. The result of this evaluation is available on the RoHS Assessment Report, which is in conformity with 2005/618/EC Article 1, amending RoHS Directive 2002/95/EC.

Peter Huang
Manager
Electronics Testing Center, Taiwan

To pursue excellence in service quality with a dedicated working attitude.

All of our LED lights have obtained RoHS certification.